

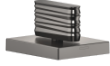





20 005 705

- avec structure WAVES
- diamètre de percement 32 mm
- rosace 60 x 47 mm
- avec marquage froid



	Dark Platinum brossé	20 005 705-99
	Chrome	20 005 705-00
	Platine brossé	20 005 705-06
	Dark Chrome	20 005 705-19
	Champagne brossé (Or 22cts)	20 005 705-46
	Champagne (Or 22cts)	20 005 705-47

20 005 705

mm [inches]



Diagramme de débit



Certificats

WRAS_1804020. IAPMO_N-4976. LGA_28687. IAPMO_4976 (4). IAPMO_6397.

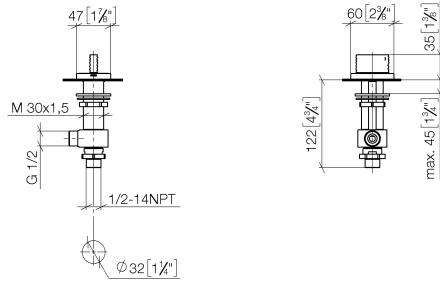
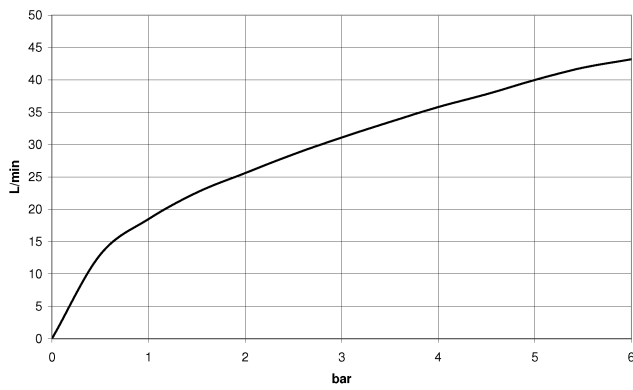
WRAS_240202020.

20 005 705

Les pièces pour les autres finitions peuvent être trouvées ici : Chrome

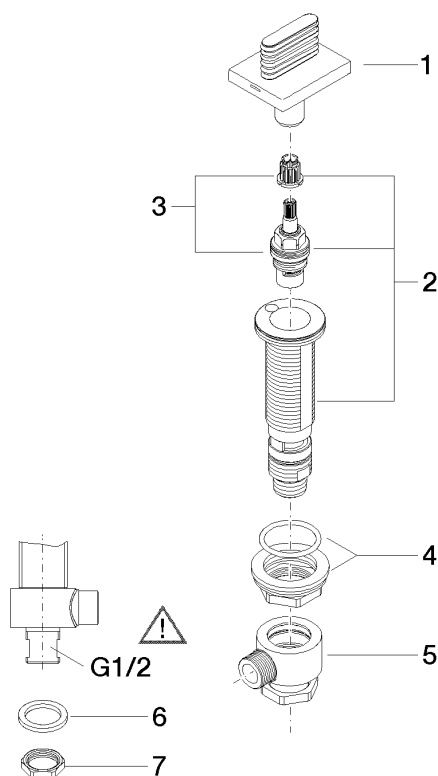

Liste des pièces de rechange

N°	Article Numéro	Désignation	Fréquence de montage	Délai de livraison
1	90 20 70 055 06-99	poignée (cold)	1	30
2	04 17 11 058 53 90	partie latérale	1	2
3	90 90 03 153 00 90	tête céramique	1	2
4	04 23 10 032 78 90	set de fixation	1	2
5	04 17 11 023 10 90	raccord multiple	1	2
6	90 23 30 040 00-99	joint américain	1	30
7	09 30 11 059 90	rondelle	1	2
8	09 23 10 012 90	écrou	1	2